

**Profile  
KOMBIT**

**Datenblatt | Datasheet**

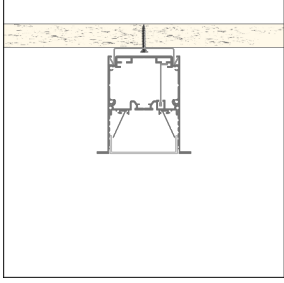
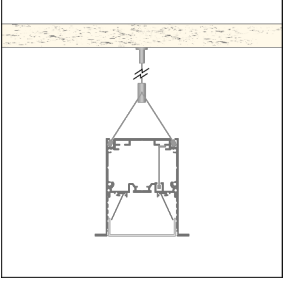
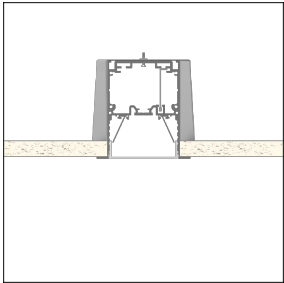
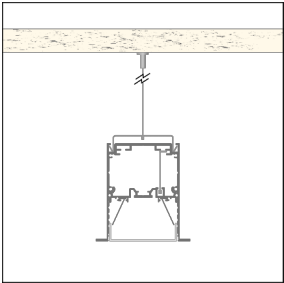
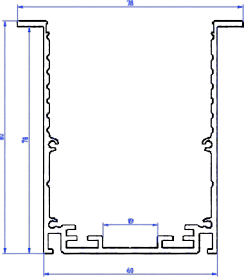
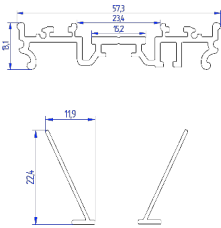
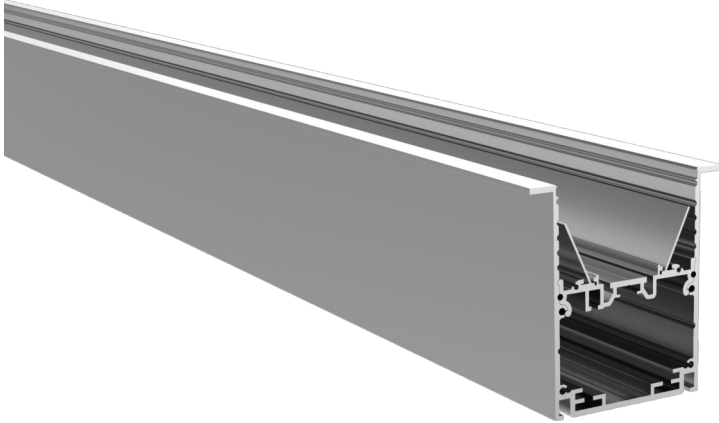

**Technische Daten:**

Material	Aluminium eloxiert
Farbe:	Aluminium-silber Pulverbeschichtung auf Anfrage
Breite:	78 mm
Höhe:	80 mm
Länge max.:	4700 mm
Gewicht (Profil):	1430 g   m
Gewicht (Einsatz):	560 g   m
Gewicht (Reflektor):	70 g   m
Artikelnummer (Profil):	#156789
Artikelnummer (Einsatz):	#156778
Artikelnummer (Reflektor):	#156779

**Technical data:**

Material	Aluminium anodized
Colour:	silver powdercoating on request
Width:	78 mm
Height:	80 mm
Length max.:	4700 mm max.
Weight (profile):	1430 g   m
Weight (inlet):	560 g   m
Weight (reflector):	70 g   m
Art. - No. (profile):	#156789
Art. - No. (inlet):	#156778
Art. - No. (reflector):	#156779



Endkappe #156797  
End cap Aluminium  
(mit Schrauben / incl. screws)



Montageclip #156785  
mounting clip V2A  
(für Seilabhangung / for wire suspension)



Montageklammer #156784  
mounting bracket V2A  
(für Deckenmontage / for ceiling mount)



Seilabhangung #156811  
Wire suspension Stahl / steel  
(mit / with #156785)



Seilabhangung „Y“ #156782  
wire suspension „Y“ Stahl / steel



Sicherheitsseil für Einsatz #156812  
Safety wire for inlet Stahl / steel



Erdungskabel #156813  
Grounding cable

**Cover  
KOMBIT**

**Datenblatt | Datasheet**

Cover opal

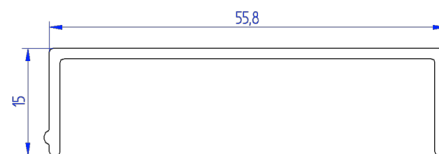

Cover transparent



**Technische Daten:**

Material	PMMA
Farbe:	Opal weiß oder transparent
Transmission:	~ 70 % (opal) / ~ 80 % (transparent)
Breite:	55,8 mm
Höhe:	15 mm
Länge max.:	5000 mm
Artikelnummer (opal)	#156780
Artikelnummer (transp.)	#156781

**Technical data:**

Material	PMMA
Colour:	opale white or transparent
Transmission:	~ 70 % (opal) / ~ 80 % (transparent)
Width:	55.8 mm
Height:	15 mm
Length max.:	5000 mm
Art.-No. (opal)	#156780
Art.-No. (transp.)	#156781